

S9C1741E



Product Family	Refrigerator
Installation	Built-in
Category	One Door
Built-in niche	178
Reference width	Until 60 cm
Reference height	160 - 200 cm
Cooling type	Fan assisted refrigerator, static freezer
Defrost	Automatic for refrigerator, manual for freezer
Hinge type	Sliding
Hinge position	Right
Reversible door	Yes
EAN code	8017709348014



Aesthetics



Aesthetic	Universale	Door shelves profile color	Silver
Colour	White	Drawers profile color	Silver
Material	Metal sheet	Color of glass shelf profile	Chrome
Side material	Steel	Display	LED
Side colour	White	Display position	Interno (sul Top)

Refrigerator compartment features



No. of adjustable shelves	4	Type of crisper/vegetable drawers cover	Glass
Number of fruit and vegetables drawers	1	No. of lights refrigerator compartment	2
Shelves material	Glass	Internal light in fridge	Yes
Type of crisper/vegetable drawers cover	On sliding rails	Type of internal light (fridge)	LED
Crisper Cover	Yes		

Refrigerator Inner Door

No. of door shelves with transparent cover	1	No. of bottle shelves	1
---	---	------------------------------	---

Number of adjustable door shelves 3

Other Refrigerator features



Accessories	Egg tray	Fan	Yes
-------------	----------	-----	-----

Freezer compartment features

Internal freezer compartment Yes

Other technical features



Functions display	Fast cooling
Door open alarm	Yes
Type of temperature control	Electronic
No. of compressors	1
Refrigerant gas type	R600a
Type of compressor	Inverter
Refrigerant Quantity (g)	48 g

Performance / Energy Label - Reg. 2019



Annual energy consumption	166 kWh/a	Airborne acoustical noise emissions	31 dB(A) re 1 pW
Energy efficiency class	E	Temperature Rise Time	14 h
Airborne acoustical noise emission class	B	4 star - Freezing capacity	5,5 kg/24h
Total net volume	286 l	Climate class	SN, N, ST
Sum of the volumes of the frozen compartment(s)	22 l	EEl	100 %
Sum of the volumes of the chill compartment(s) and the unfrozen compartment(s)	264 l		

Electrical Connection





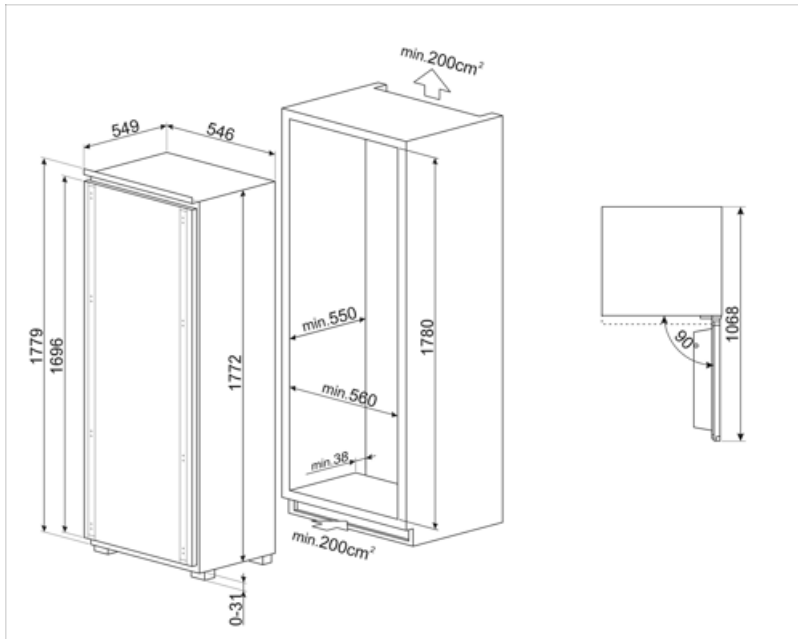

Electrical connection rating	130 W	Frequency (Hz)	50 Hz
Current	1 A	Power supply cable length	240 cm
Voltage (V)	230-240 V	Plug	(F;E) Schuko

Logistic Information

Width	546 mm	Depth of the built-in niche	550 mm
Width of the built-in niche	560 mm	Height	1772 mm
Depth without handle	549 mm	Height of the built-in niche	1780 mm



Symbols glossary

- | | | | |
|--|---|---|--|
|  | The automatic defrost system works by automatically defrosting at regular intervals eliminating the need to defrost altogether. |  | Energy efficiency class E |
|  | LED display: to show programmes, functions and options selected and the time to the end of the cycle. |  | Ventilated: Forced distribution of cold air in the refrigerator compartment, which allows even temperature distribution within the fridge. |
|  | LED interior lighting: is a more energy efficient and long lasting way of illuminating the interior of the appliance. |  | Smeg's evolution towards more intelligent and eco-friendly models has led to the choice of Inverter technology, which significantly reduces consumption. |
|  | Built-in niche | | |